

**Electronics II (EEE 232)****Assignment # 02, BS (EE) - IV, Fall 2014**

Total Marks: 25**Deadline: 1315 Hours, Monday, November 17, 2014.****Instructions:**

1. This is a group assignment and all the deliverables should be submitted as a group.
2. The groups will be according to the attached list.
3. Cooperation between the groups is not allowed.
4. The groups cannot be changed. Any request to do so will not be entertained.
5. Report and presentation must be submitted in both hard and soft format.
6. Presentation schedule will be provided later.
7. The report and presentation will be checked for plagiarism. Plagiarized assignments will be cancelled.

Task:

Read/ analyze the attached paper and submit a study report (maximum 3 pages) summarizing the concepts presented in the paper. Also prepare a five minute presentation that can be presented during one of the lectures.

Deliverables:

1. Study report (maximum 3 pages) in printed and soft format (PDF).
2. A power point presentation spanning 5 minutes.

Points Distribution:

All the assignments will be marked according to the following criteria

Report: 10 Points.

Presentation: 5 Points.

Group work: 10 Points.

Group List

Group #	Group Members	Group #	
01	Fazal Subhan Asfand Yar Ali Shah	13	Hafeez ur Rehman Muhammad Ali Rizwan
02	Muhammad Wasif Shahzad Huma Siddique	14	Aqeel Ahmed Adeel Ahmad Khan
03	Mujahid Hussain Qazi Fatehullah	15	Tanveer Ahmed Awais Mehmood
04	Aasim Zia Muhammad Shahbaz	16	Hamid Ali Khan Imad Hussain
05	Muhammad Mudasser Muhammad Badar Ali	17	Baseer Ahmed Piracha Faiza Gul
06	Sadia Saeed Malik Syed Nabeel Hussain Shah	18	Maqbool Ahmed Bilal Ahmed
07	Ghulam Mujtaba Roohullah	19	Maaz Khan Muhammad Jawad Khan
08	Muhammad Faran Shah Osama Omer Abdullah	20	Ali Khan Suleman Safeer
09	Muhammad Sarosh Khurshid Muhammad Ehtesham Khan	21	Shahbaz Ali Muhammad Yasin
10	Muhammad Junaid Awais Ali Khan	22	Muhammad Usman Ishtiaq Zulqarnain
11	Naveed Azam Iqtidar Hussain		
12	Hammad Hassan Ali Sarfaraz		

Engineering Silence: Active Noise Cancellation

Michael Benoit **Christopher Camastra** **Melissa Kenny**
datdo6@gmail.com home_b_slice@embarqmail.com leopard793@comcast.net

Kimberly Li **Richard Romanowski** **Kevin Shannon**
kq.li@att.net romanowskisoccer16@gmail.com kshannon@pds.org

Abstract

In order to create active noise canceling headphones, a pair of Sennheiser HD 202 headphones was modified with microphones and a series of op-amp circuits. Attenuation of low frequency ambient noise was successfully observed.

Introduction

Noise cancellation technology is aimed at reducing unwanted ambient sound, and is implemented through two different methods. The first of these is passive noise cancellation: an approach that focuses on preventing sound waves from reaching the eardrum, and includes devices such as circumaural headphones or earbuds [3]. The other technique used to achieve the same – and often better – result is active noise cancellation, which uses aural overlap and destructive interference to target and attenuate background noise. While passive and active noise cancellation may be applied separately, they are often combined to attain maximum effectiveness in noise cancellation.

Although active noise canceling devices are still being integrated commercially, the concept has existed since the beginning of the 20th century. In 1933, a German patent was issued to a Paul Lueg for the concept of active noise cancellation; he was the first to realize the possibility of attenuating background noise by superimposing a phase flipped wave [5]. In the 1950s, Olsen successfully demonstrated Lueg's concept in rooms, ducts, and headsets [5]. Research and development of active noise reduction (ANR) headphones truly began in 1978 after Dr. Amar Bose felt the need to develop headphones that masked the low rumbling of plane engines and other cabin noises [6]. With the invention of integrated circuits – op-amp circuits – and miniature microphones, the existence of ANR headsets became increasingly probable.

ANR headsets were first used in the Armed Forces, and constantly develop in versatility. However, they are not used in all military organizations and are only slowly being commercially released [2]. Current applications include noise propagation in industrial air handling systems, reduction of propeller noise in aircrafts and tonal noise from electric power, as well as isolation of vibration from noise

radiating structures. Even with these applications, the transition of active noise control from the laboratory to the market is far from complete [4].

A hands-on implementation of noise canceling headphones provides for a strong understanding of the conceptual framework of both passive and active noise canceling. In addition, it allows an introduction to the basic components and operations of analog circuits. In particular, attention is given to the theory behind resistor networks, op-amp circuits, and filtering circuits. Secondary goals of the project include learning about the importance of circuit design, using oscilloscopes to understand and test circuits, and mastering the skills involved in building circuits.

Background Information and Related Work

The Original Headphones

The constructed headphones implement both passive and active noise cancellation via the modification of a pair of Sennheiser HD 202 headphones (Figure 1). The Sennheiser headphones



Figure 1: Sennheiser HD 202 Headphones [10]

come equipped with passive noise canceling components such as closed,

semi-circumaural ear pads [10]. In order to achieve active noise cancellation, a circuit mainly comprised of a series of op-amps and microphones was added to the headphones for active noise cancellation.

Circuit Laws

Before constructing the noise canceling circuit, a general comprehension of circuitry was required to fully understand how the specific noise canceling circuit operates. Every circuit contains various components, each of which have correlative quantities; these quantities are often measured during circuit construction and may be altered in order to produce the proper results. The most common of such quantities include the voltage, current, and resistance of the circuit components. The voltage represents the potential difference needed to move a unit of charge across any circuit component. The current specifies the rate at which a unit of charge flows through a given component of the circuit. The resistance of a component describes the impedance against the current for that specific component.

The relationship between these measurements – voltage, current, and resistance – in a circuit is commonly known as Ohm’s Law. Ohm’s Law states that the voltage drop across two points is the product of the current and the resistance ($V=IR$, where V is the voltage, I is the current, and R is the resistance).

Oftentimes, Ohm’s Law is used in conjunction with other mathematical relationships derived from the circuit for analysis. There are two other fundamental circuit laws, known as Kirchoff’s Laws: the Junction Rule and

the Loop Rule. The Junction Rule results from the conservation of charge; it states that at any junction or node the algebraic sum of all the currents equals zero. In other words, the amount of current that enters the node must also leave the node (Figure 2). The Loop Rule, derived from

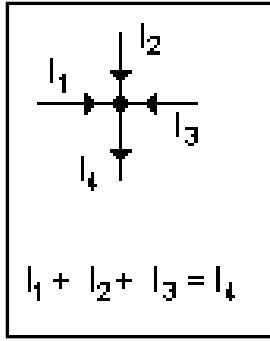

Figure 2: The Junction Rule

the conservation of electrostatic fields, states that the algebraic sum of the voltages in any loop is zero (Figure 3). These laws help understand the transfer of energy through

an electrical circuit, as well as analyzing them.

When a circuit contains more than one resistor, the resistors can be treated as one resistor and can be simplified in two ways depending on how they are

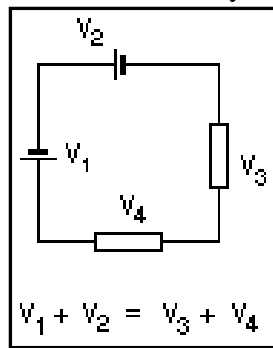

Figure 3: The Loop Rule

arranged – in series or in parallel. When connected in series, resistors are connected end-to-end with one another. The current entering and leaving each resistor is the same according to the Junction Rule, so the total resistance of the circuit is the voltage difference divided by the current (Figure 4).

$$R_{Total} = \frac{V}{I} = \frac{V_1 + V_2 + V_3 + \dots}{I} = \frac{V_1}{I_1} + \frac{V_2}{I_2} + \frac{V_3}{I_3} + \dots$$

$$R_{Total} = R_1 + R_2 + R_3 + \dots$$

Figure 4: Resistors in Series

Circuit Components

Resistors are also connected in parallel so that when the circuit forks into different branches – each containing a resistor – the potential difference between where the branches diverge and from where the branches converge must add up with all the other voltage drops. This, once again, is a restatement of the Kirchoff's Law, but in this case, the Loop Rule (Figure 5). For each resistor

$$\frac{V}{R_{Total}} = I = I_1 + I_2 + I_3 + \dots = \frac{V_1}{R_1} + \frac{V_2}{R_2} + \frac{V_3}{R_3} + \dots$$

$$\frac{1}{R_{Total}} = \frac{1}{R_1} + \frac{1}{R_2} + \frac{1}{R_3} + \dots$$

Figure 5: Resistors in Parallel

added in parallel, the total resistance actually decreases and is always less than the individual resistance of each resistor involved.

Another common principle observed in the treatment of circuits is that of voltage and current division. Voltage and current division specify the manner in which the voltage and current is shared among the various components of a circuit, and can be easily derived from Ohm's Law and Kirchoff's Laws. The voltage across one resistor in series is proportional to the total voltage with a ratio of the resistance of said resistor over the total resistance of all the resistors connected in series (Figure 6).

$$V_T = IR_T$$

$$R_T = R_1 + R_2 + R_3 + \dots$$

$$I = \frac{V_T}{R_T} = \frac{V_T}{R_1 + R_2 + R_3 + \dots} = \frac{V_n}{R_n}$$

$$V_n = \frac{R_n}{R_1 + R_2 + R_3 + \dots} V_T$$

Figure 6: Voltage Division: Resistors in Series

Also, the current through one resistor in parallel is proportional to the total current through the entire parallel system downsized by the ratio of the inverse of the resistor over the inverse of the total resistance through the entire system (Figure 7).

$$\begin{aligned} \text{let : } G &= \frac{1}{R} \\ V &= I_T R_T = \frac{I_T}{G_T} \\ V &= \frac{I_n}{G_n} \\ I_n &= \frac{G_n}{G_t} I_t \\ I_n &= \frac{G_n}{G_1 + G_2 + G_3 + \dots} I_t \end{aligned}$$

Figure 7: Current Division: Resistors in Parallel

These principles were applied with operational amplifiers (op-amps) to achieve the desired result. An op-amp is an electronic voltage amplifier most commonly used to perform single-process operations, mainly mathematical operations on analog circuits. Although they are fairly complex devices, op-amps are often modeled as simpler components, referred to as ideal op-amps. An ideal op-amp operates under two conditions: the currents in both inputs are equal to zero and the voltages across both inputs are equal to one another. In the traditional diagram of an op-amp, V_+ is the non-inverting input, V_- is the inverting input, V_{Out} is the output, V_{s+} is the positive power supply, and V_{s-} is the negative power supply (Figure 8).

Some basic uses of op-amps in analog circuits include summing and difference amplifiers, and inverting and

non-inverting amplifiers. Each op-amp has its own transfer function, which describes the relationship between the input and final output voltage of the op-amp.

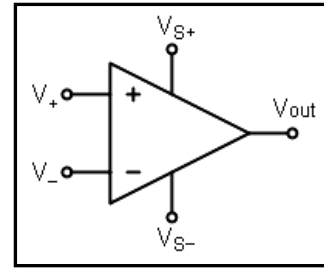

Figure 8: Op-Amp

The transfer functions are dependent on configurations and values of the resistors connected to the op-amps. For the noise-canceling circuit, op-amps were readily used to perform simple signal processing operations.

Another electrical component crucial to the noise-canceling circuit is the capacitor, which stores energy between two conductive plates. When a potential difference exists across a capacitor, the current deposits electric charge on one plate and causes a build-up of charge on both plates of the capacitor. This stored electrical energy is then released through a resistor when necessary. An RC circuit, which consists of a resistor and a capacitor wired in series, is often used as a filter, differentiating between high and low frequency signals. A filtering circuit eliminates a range of frequencies from a mixture of frequencies, like minimizing the bass of a song so the melody is more prominent. If the output voltage is taken across the resistor, the low frequencies are attenuated, and the device is termed as a high-pass filter. If the output voltage is taken across the capacitor, the high frequencies are attenuated, making the device a low-pass filter.

Active Noise Canceling

The headphones use active noise cancellation to eliminate any low-frequency noise from the environment, leaving the music to play from the headphones without the noise waves. To do this, the device produces a wave identical in frequency to the noise wave, but phase-flipped by a phase-shift of 180 degrees [1]. Afterwards, the generated wave is superimposed onto the noise wave, and the addition of these two waves – destructive interference – causes them to mutually cancel (Figure 9). Though the headphones play the music, the noise waves, and the generated waves, the destructive interference allows only the music to be heard by the listener.

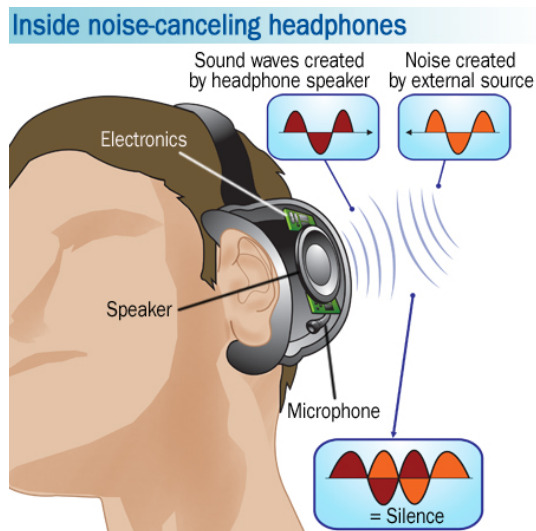

Figure 9: Two waves are shifted 180 degrees with respect to each other so that the waves destructively interfere. [5]

This method of active noise cancellation is achieved by superimposing generated anti-noise with the noise signal. The system also includes other additional components in order for the active noise cancellation to

function properly. A microphone, which is placed externally on the headphones, is needed to detect and obtain the raw noise signal from the outside environment (Figure 10). The circuit generates an anti-noise signal that destructively interferes with the noise signal. A speaker – in this case, the headphones – then required feeds the generated wave to the music and the noise wave in order for the generated wave and the noise wave to destructively interfere with one another. An external source of energy supplies the system with the ability to operate, which is also the reason for the term “*active* noise cancellation” – active meaning the need for an external source. Theoretically, active noise canceling is capable of reducing ambient noise up to 70 percent, and is most effective when used for air travel or other low-frequency sound waves [5].

Experimental and Engineering Design

As described previously, the signal undergoes various changes in order to result in the desired output. The circuit in the noise canceling system can be divided into three stages with each containing an op-amp circuit that alters the analog signal in a unique way (Figure 11).

Pre-Amplifier

The first section in the circuit schematic is a non-inverting pre-amplifier, the second a phase inverting op-amp configuration, and the third is a signal-summing amplifier. These three main components of the circuit lead into one another consecutively, modifying

the signal as it passes through the device. The noise-canceling headphones contain

microphone is very weak and must be amplified if it is to be usable. The gain in

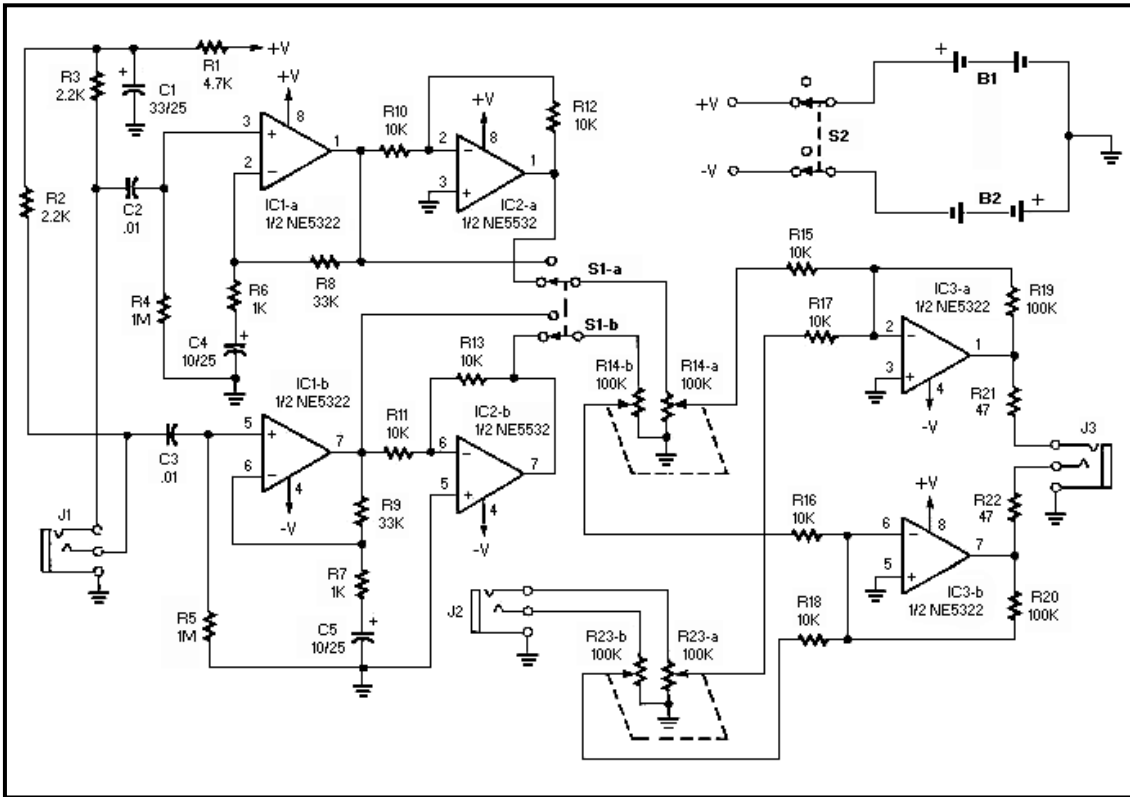

Figure 11: Complete Circuit Schematic

two separate channels, in order to maintain stereo sound. These two channels are identical, and run parallel to each other. Noise cancellation is achieved by passing an analog audio signal through these three sections of circuitry.

The first part of the circuit is a non-inverting op-amp circuit that acts as

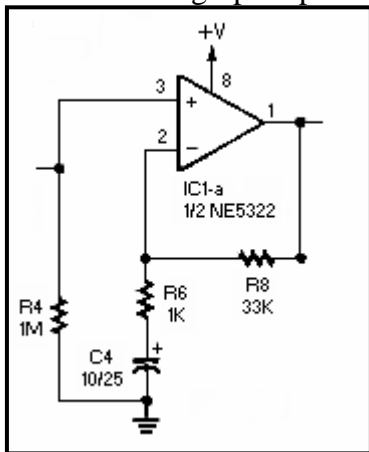

Figure 12: Pre-Amplifier

a pre-amplifier (Figure 12). A pre-amp is necessary in the circuit because the audio signal output from the

our pre-amp is determined by the ratio between R_8 and R_6 . By altering the values of these two resistors, it is possible to control the amplitude of the audio signal as it leaves the pre-amp. Once the weak microphone signal is amplified, the output is sent to the input of the phase-inverter.

The second component of the circuit is an inverting op-amp circuit (Figure

13). This circuit inverts the phase of the signal by changing the

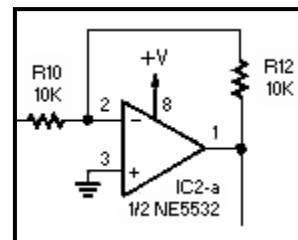

Figure 13: Inverting Op-Amp Circuit

polarity of the signal's voltage as it leaves the op-amp. The amplification of this op-amp circuit is controlled by the ratio between R_{12} and R_{10} . For this circuit, the resistances of R_{12} and R_{10} have are equal – creating a multiplier of one – because there is no longer a need to change the amplitude of the input wave. This unitary-gain circuit also cuts back on any distortion of the audio signal. This section features a switch that provides the option of turning noise canceling on or off by selecting either a phase-inverted signal or the raw signal from the pre-amp. The output of this op-amp circuit goes into a potentiometer that adjusts the gain of the entire circuit's signal up to that point. The potentiometer allows control over the amplitude of the phase shifted noise signal, and thus grants the user the ability to fine-tune the noise canceling. Ideal noise cancellation is achieved when the amplitude of the inverted noise signal matches that of the unwanted noise on the outside. The output from this potentiometer is fed into a summing amplifier.

The third component of the circuit is a summing amplifier that mixes the inverted noise signal with an auxiliary input such as music (Figure 14). It outputs the final signal to the

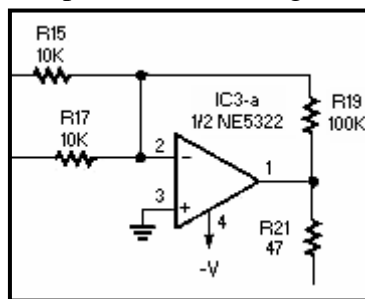

Figure 14: Summing Op-Amp Circuit

headphones. The gain of this signal

mixer is controlled by the ratio between R_{19} and R_{15} . The summing amplifier combines the two analog signals and plays both through the same speaker. The auxiliary input of this circuit first passes through a potentiometer, which controls the amplitude of the music. The output of this summing amplifier is the last part of the noise-canceling circuit before the signal is sent to the speaker.

The circuit is built in two parts because there needs to be a noise canceling circuit for each side of the headphones – right and left. After the two parts are individually constructed, the identical circuits are wired together and placed into an aluminum box for containment.

Results and Discussion

The construction of the circuit for noise cancellation was moderately successful in this project. After completion, the ANR headphones worked fairly well, and were able to cancel out a majority of the background noise. It was also able to amplify background noise through an added switch that bypassed the phase-inverting op-amp. In order to test the effectiveness of the completed headphones, an oscilloscope was used to detect the sound waves before and after each op-amp in the circuit.

The first op-amp's purpose was to amplify the sound detected by microphone. The efficiency of this op-amp is displayed in the comparison of the two graphs (Figure 15a and Figure 15b). In Figure 15a, the noise signal had small amplitude, whereas in Figure 15b, the noise was greatly amplified, as shown by its increased amplitude.

The second op-amp was used to invert the phase of the noise. The

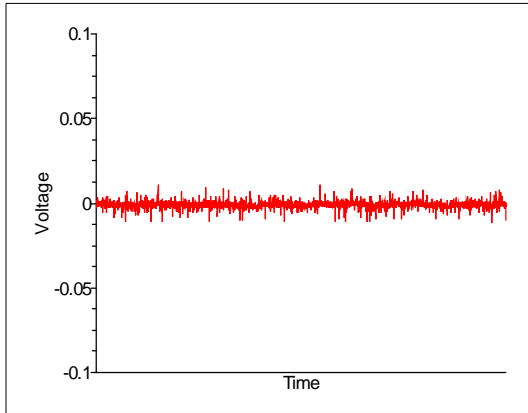

Figure 15a: Before Amplification

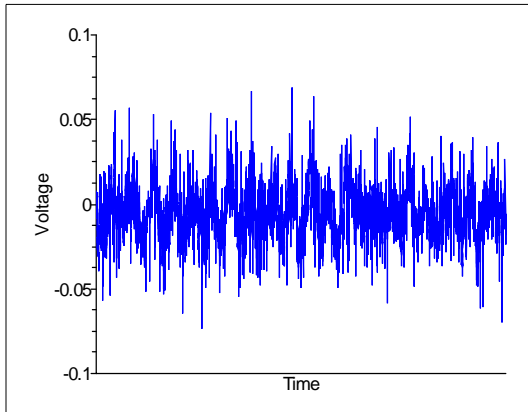

Figure 15b: After Amplification

success of this piece of the circuit is illustrated in the next pair of graphs (Figure 16a and 16b). Figure 16a illustrates the amplified noise before being inverted, and Figure 16b shows the noise signal after being inverted. Note how the signal is exactly the same,

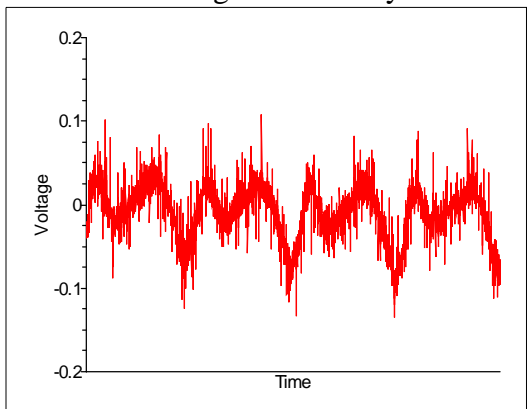

Figure 16a: Before Inversion

except flipped over the horizontal axis.

The third and final op-amp's

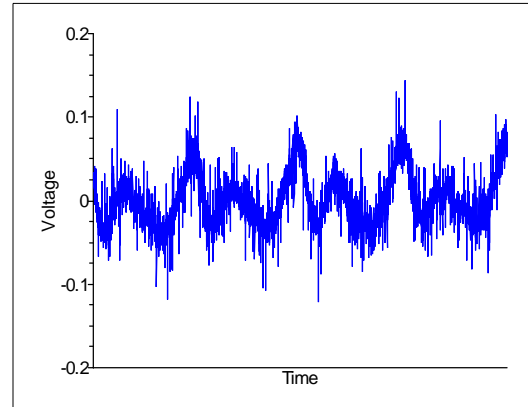

Figure 16b: After Inversion

objective was to add the now inverted noise to the background noise and music. This effectiveness of this portion of the circuit can be seen by the following three graphs (Figure 17a, Figure 17b, and Figure 17c). Figure 17a shows the noise signal before summation while Figure 17b shows the sine wave of

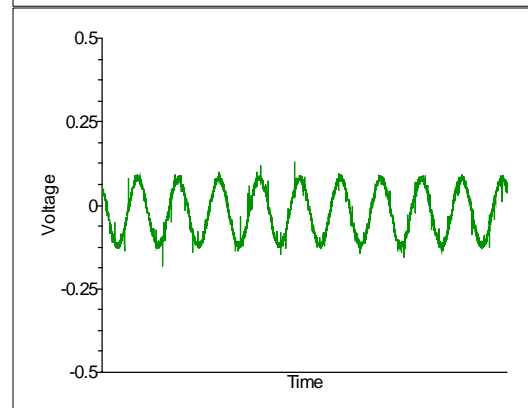
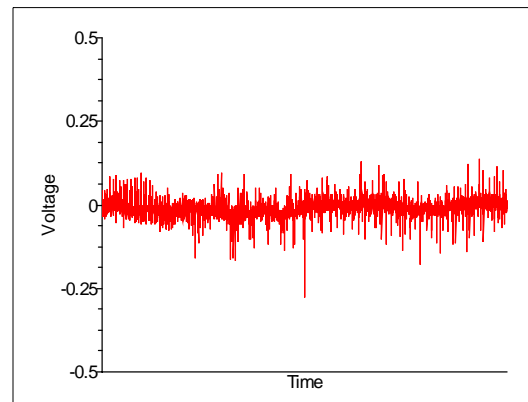

Figure 17b: Auxiliary Input

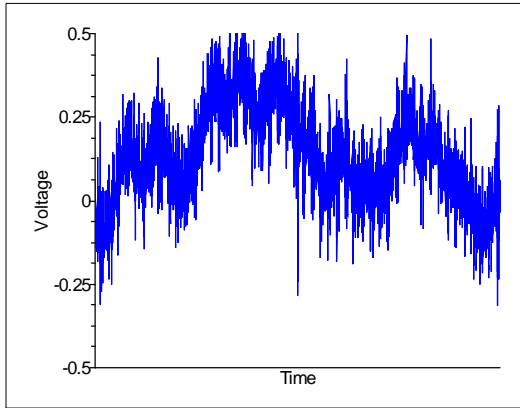

Figure 17c: Final Output

the music before summation. Figure 17c simply shows the combined noise signal and sine wave of the music. This combined signal is the final signal outputted into the headphones.

The noise canceling headphones were tested by observing their effect on various sources of noise such as an air conditioning vent, human voice, and a fan. In all cases, low frequency sound waves were attenuated. However, this means that certain sounds are not cancelled. For example, fan noise will not be entirely cancelled; instead, the fan takes on a higher-pitched sound, as if the diameter of the fan were reduced. Also, when noise canceling is turned off, the circuit acts as a noise amplifier, giving the auxiliary input a static-like effect. Some undesired results occur in our circuit, such as occasional feedback from the microphones.

Future Work

The relatively simple circuit for noise cancellation that was implemented leaves many opportunities for improvement. The first improvement possible is miniaturization, in which the noise-canceling circuitry could be placed in the headphones themselves. The circuit is currently housed in a hand-held aluminum casing. Had there been more

time, the circuit schematic would have been sent out for the connections to be printed directly onto a circuit board. This would eliminate the bulky enclosure and the cord that connects the microphones to the circuitry.

Another improvement is the addition of a negative feedback circuit. Such a circuit would use the volume of the background noise to regulate the level of noise canceling needed. This would simplify the ease of use of the device by eliminating the need for manual fine-tuning.

Another possibility is to convert the analog signal into a digital one. This grants greater flexibility, as the digital signal could be sent to a digital signal processor, and noise canceling could be handled by software. Such a change would allow the circuit to handle more advanced processing and to develop as new advances in noise-canceling technology are discovered. One example of this is adaptive noise cancellation, which takes negative feedback a step further by allowing it to adjust the cancellation level based on a mathematical model. The model includes specific coefficients governed by the input signal level and frequencies; traditional negative feedback only uses the raw signal level to adjust the volume of noise cancellation [7].

The noise-canceling technology could also be applied to other areas of audio hardware. For example, a microphone filter that removes static from a microphone signal could be constructed. Another field that could benefit from noise canceling is telecommunications. Currently, noise cancellation is used to filter out ambient noise from telephone conversations. This relies on a similar method to the headphones, where separate

microphones are used for the noise and the desired signal [8]. However, the noise canceling circuit could also be used in a telephone to detect noise from signal degradation and to cancel such noise before it travels through the phone's speaker. Because the noise is introduced into the signal en route to its destination, the unwanted noise and the desired signal would be combined into one signal. This is in contrast to the headphones, which have the two components in separate signals. To remedy this problem, an adaptive algorithm that can separate the noise from the desired signal would be implemented.

Conclusion

During the course of this research project, the members of the research group have learned about many facets of noise canceling, as well as electrical engineering in general. In addition to basic necessary skills such as soldering, the members also received a window into the world of analog circuit design and implementation. Much experience with electrical analysis equipment, such as oscilloscopes and function generators, was gained as well.

One aspect about electrical engineering learned is how tedious circuit analysis is. Because the circuits are too small to attach the leads to the equipment, additional wires needed to be

added in order to test different parts. This meant that whenever a different part of the circuit needed to be tested, wires needed to be added and removed. This caused the circuitry to become sloppy, and errors, such as solder bridging, to occur. However, these issues were surmountable, and it was very exciting to be able to visualize the actual

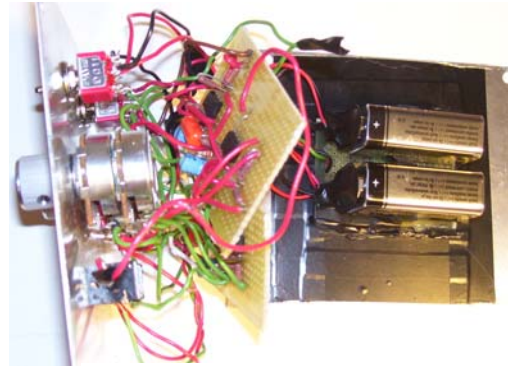

Figure 18: Completed Circuit

electrical signal being sent through our circuit (Figure 18).

As mentioned previously, the circuit only operates at low frequencies, so some noise is not cancelled. Furthermore, the circuit requires a great deal of fine-tuning in order for the phase-inverted noise and the original noise to share the same amplitude. However, the circuit works well enough to demonstrate how passive and active noise canceling operates. The members of this research group personally enjoyed the project, and feel that it gave them a grasp on the concepts behind electrical engineering and circuit design.

Acknowledgements

We would like to thank Abhishek Agrawal and Mason Liang for their help in teaching us about electrical engineering and analog circuit design as well as helping us to construct our noise canceling circuit. We appreciated the opportunity of being able to work at the facilities of Princeton University. The circuit schematic and directions for modification are accredited to Jules Ryckebusch, who submitted the project "Build These Noise-Canceling Headphones" to HeadWize.com [9]. We would also like to thank Dean Don Brown, Dean Ilene Rosen, Blase Ur, Stephanie Chen, Ms. Jane Oates and the Governor's School Board of Overseers, and the rest of the Governor's School of Engineering and Technology staff for giving us the opportunity to complete this research project.

Citations

- 1) Agrawal, Abhishek. "Project Overview." Engineering Silence - Active Noise Canceling. Summer 2007. 12 July 2007 <<http://www.princeton.edu/~abhishek/noise/overview.html>>.
- 2) Buck, K, and V Zimpfer-Jost. "Active Hearing Protection Systems and Their Performance." NATO. 17 July 2007 <<http://stinet.dtic.mil/cgi-bin/GetTRDoc?AD=ADA444679&Location=U2&doc=GetTRDoc.pdf>>.
- 3) Carnoy, David, Steve Guttenberg, and Eliot Van Buskirk. "The Sound of Silence." CNET Reviews. 19 July 2005. 12 July 2007 <http://reviews.cnet.com/4520-3000_7-1017728-1.html>.
- 4) Hansen, Colin H. "Innovative Noise Control." Safety Matters 2. 17 July 2007 <http://www.siso.org.sg/www/components/com_e-zine/pdf/eZine,03Q2.pdf>.
- 5) Harris, Bill. "How Noise-canceling Headphones Work." Howstuffworks. 16 July 2007 <<http://electronics.howstuffworks.com/noise-canceling-headphone.htm>>.
- 6) "History of Acoustic Noise Cancelling® Headphones." BOSE. 17 July 2007 <http://www.bose.com/controller?event=VIEW_STATIC_PAGE_EVENT&url=/home_entertainment/anch_family/index.jsp&ck=0&pageName=/cgi-bin/htsearch>.
- 7) Makineni, Sree GowriShankarPrasad. "Adaptive Interference Cancelling." Noise Reduction Using an Adaptive Filter. 11 Dec. 1995. 19 July 2007 <<http://www.ee.duke.edu/~gsm/projects/adap-filter/pro.html>>. Path: Adaptive Interference Cancelling.
- 8) Nasar, Alan S. "Considerations in Applying Noise Cancellation Techniques to Telephones." Acoustical Society of America. 15 May 1996. 19 July 2007 <<http://www.acoustics.org/press/131st/lay08.html>>.

- 9) Ryckebusch, Jules. "Build These Noise-Canceling Headphones." HeadWize. 2001. 12 July 2007 <http://www.headwize.com/projects/noise_prj.htm>.
- 10) Sennheiser HD 202. 12 July 2007 <<http://www.sennheiserusa.com/newsite/> : Headphones and Headsets; DJs; HD202>.